



INDUS-CONNECTOR M5 circular connectors are ideal for many applications where a small yet rugged and compact connector solution is required to deliver a secure and reliable signal transfer. Various M5 connector applications include transportation and control systems, automated doors & ramps, sensor connectivity as well as many data & communication device applications. Protection class is IP67 when mated. 3pins and 4pins gold-plated brass contacts with a rated current of 1 A at 60 V can be selected.

M5是M系列连接器中最小的一种。M5分为PVC外被和PUR外被的直头和弯头连接线，也有各种各样的锁面板连接器。这种连接器特别适合自动化领域，依靠螺丝锁紧可以达到IP67防护等级。可选择3芯和4芯，且电流都为1A、电压60V。

## M5 male metal waterproof cap/M5公头金属防水帽

Scale drawing/尺寸图

Product photo/产品图

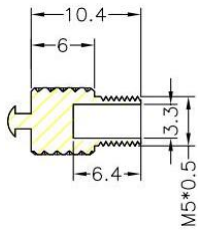

Part number/产品料号

5CAP002

General data/常规数据

Standards/标准	IEC 61076-2-105
Degree of protection/防护等级	IP67, IP68, IP69K
Screw/螺丝	Brass with nickel plated/黄铜镀镍
Customs tariff number/海关编码	8538900000
Environmental compliance/环境符合标准	RoHS, Reach

## M5 male metal waterproof cap with stainless steel chain/M5公头防水帽带不锈钢绳

Scale drawing/尺寸图

Product photo/产品图

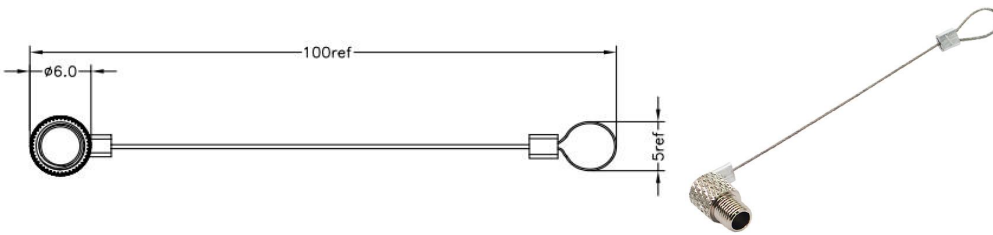

Part number/产品料号

5CAP003-100

General data/常规数据

Standards/标准	IEC 61076-2-105
Degree of protection/防护等级	IP67, IP68, IP69K
Screw/螺丝	Brass with nickel plated/黄铜镀镍
Chain/绳子	Stainless steel/不锈钢
Customs tariff number/海关编码	8538900000
Environmental compliance/环境符合标准	RoHS, Reach

## M5 male moldable connector, unshielded/M5公头成型式连接器, 不带屏蔽

Scale drawing/尺寸图

Product photo/产品图

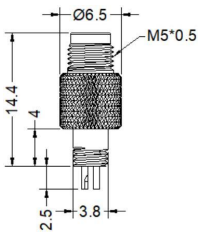

Part number/产品料号

Pins/针数	Part number/产品料号
3pins/3针	5C001
4pins/4针	5C003

Pin assignment front view/针位分布前视图

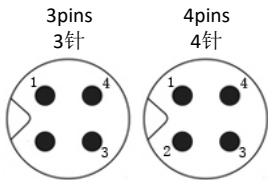

General data/常规数据

Pin numbers/针数	3pins/3针	4pins/4针
Rated voltage/额定电压	60V	
Rated current(40°C)/额定电流	1A	
Standards/标准	IEC 61076-2-105	
Termination/焊接方式	Solder/焊接	
Connector locking system/锁紧方式	Screw/螺锁	
Degree of protection/防护等级	IP67, IP68, IP69K	
Wire gauge(mm²)/线规(平方数)	0.14mm²	
Wire gauge(AWG)/线号(平方数)	26AWG	
Mechanical operation/插拔次数	>100 mating cycles/大于100次	
Ambient temperature(operation)/操作温度	-25°C~+85°C	
Contact resistance/接触电阻	≤5mΩ	
Insulation resistance/绝缘电阻	≥100MΩ	
Connector body/胶芯	TPU	
Pin/端子	Brass with gold plated/黄铜镀金	
Nut and shell/螺母和铜壳	Brass with nickel plated/黄铜镀镍	
Customs tariff number/海关编码	8538900000	
Environmental compliance/环境符合标准	RoHs, Reach	

## M5 female moldable connector, unshielded/M5母头成型式连接器, 不带屏蔽

Scale drawing/尺寸图

Product photo/产品图

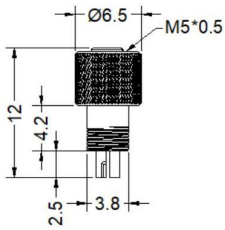

### Part number/产品料号

Pins/孔数	Part number/产品料号
3pins/3孔	5C002
4pins/4孔	5C004

### Pin assignment front view/针位分布前视图

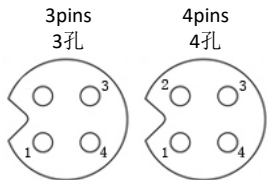

### General data/常规数据

Pin numbers/针数	3pins/3针	4pins/4针
Rated voltage/额定电压	60V	
Rated current(40°C)/额定电流	1A	
Standards/标准	IEC 61076-2-105	
Termination/焊接方式	Solder/焊接	
Connector locking system/锁紧方式	Screw/螺锁	
Degree of protection/防护等级	IP67, IP68, IP69K	
Wire gauge(mm²)/线规(平方数)	0.14mm²	
Wire gauge(AWG)/线号(平方数)	26AWG	
Mechanical operation/插拔次数	>100 mating cycles/大于100次	
Ambient temperature(operation)/操作温度	-25°C~+85°C	
Contact resistance/接触电阻	≤5mΩ	
Insulation resistance/绝缘电阻	≥100MΩ	
Connector body/胶芯	TPU	
Pin/端子	Phosphorus copper with gold plated/磷铜镀金	
Nut and shell/螺母和铜壳	Brass with nickel plated/黄铜镀镍	
Gasket/胶圈	Fluorine ring/氟胶圈	
Customs tariff number/海关编码	8538900000	
Environmental compliance/环境符合标准	RoHs, Reach	

## M5 male straight front panel mount connector, unshielded, insert/M5公头直头前锁面板板端, 不带屏蔽

Scale drawing/尺寸图

Product photo/产品图

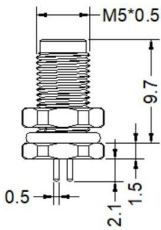

Part number/产品料号

Pins/针数	Part number/产品料号
3pins/3针	5B005
4pins/4针	5B001

Pin assignment front view/针位分布前视图

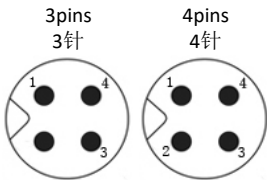

General data/常规数据

Pin numbers/针数	3pins/3针	4pins/4针
Rated voltage/额定电压	60V	
Rated current(40°C)/额定电流	1A	
Standards/标准	IEC 61076-2-105	
Termination/焊接方式	Dip-solder/浸焊	
Connector locking system/锁紧方式	Screw/螺锁	
Degree of protection/防护等级	IP67, IP68, IP69K	
Mechanical operation/插拔次数	>100 mating cycles/大于100次	
Ambient temperature(operation)/操作温度	-25°C~+85°C	
Contact resistance/接触电阻	≤5mΩ	
Insulation resistance/绝缘电阻	≥100MΩ	
Connector body/胶芯	TPU	
Pin/端子	Brass with gold plated/黄铜镀金	
Nut and shell/螺母和铜壳	Brass with nickel plated/黄铜镀镍	
Gasket/胶圈	Fluorine ring/氟胶圈	
Black glue/黑色胶水	Epoxy resin/环氧树脂	
Customs tariff number/海关编码	8538900000	
Environmental compliance/环境符合标准	RoHs, Reach	

**M5 male straight rear panel mount connector, unshielded, insert/M5公头直头后锁面板板端, 不带屏蔽**

Scale drawing/尺寸图

Product photo/产品图

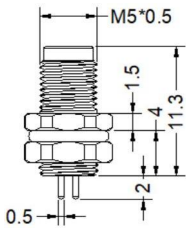

Part number/产品料号

Pins/针数	Part number/产品料号
3pins/3针	5B006
4pins/4针	5B002

Pin assignment front view/针位分布前视图

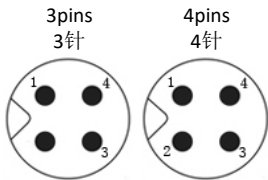

General data/常规数据

Pin numbers/针数	3pins/3针	4pins/4针
Rated voltage/额定电压	60V	
Rated current(40°C)/额定电流	1A	
Standards/标准	IEC 61076-2-105	
Termination/焊接方式	Dip-solder/浸焊	
Connector locking system/锁紧方式	Screw/螺锁	
Degree of protection/防护等级	IP67, IP68, IP69K	
Mechanical operation/插拔次数	>100 mating cycles/大于100次	
Ambient temperature(operation)/操作温度	-25°C~+85°C	
Contact resistance/接触电阻	≤5mΩ	
Insulation resistance/绝缘电阻	≥100MΩ	
Connector body/胶芯	TPU	
Pin/端子	Brass with gold plated/黄铜镀金	
Nut and shell/螺母和铜壳	Brass with nickel plated/黄铜镀镍	
Gasket/胶圈	Fluorine ring/氟胶圈	
Black glue/黑色胶水	Epoxy resin/环氧树脂	
Customs tariff number/海关编码	8538900000	
Environmental compliance/环境符合标准	RoHs, Reach	

## M5 female straight front panel mount connector, unshielded, insert/M5母头直头前锁面板板端, 不带屏蔽

Scale drawing/尺寸图

Product photo/产品图

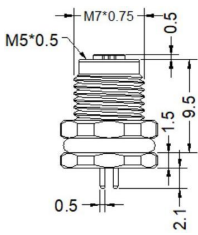

Part number/产品料号

Pins/孔数	Part number/产品料号
3pins/3孔	5B007
4pins/4孔	5B003

Pin assignment front view/针位分布前视图

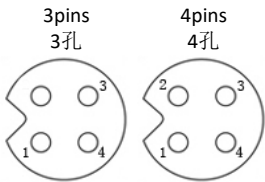

General data/常规数据

Pin numbers/孔数	3pins/3孔	4pins/4孔
Rated voltage/额定电压	60V	
Rated current(40°C)/额定电流	1A	
Standards/标准	IEC 61076-2-105	
Termination/焊接方式	Dip-solder/浸焊	
Connector locking system/锁紧方式	Screw/螺锁	
Degree of protection/防护等级	IP67, IP68, IP69K	
Mechanical operation/插拔次数	>100 mating cycles/大于100次	
Ambient temperature(operation)/操作温度	-25°C~+85°C	
Contact resistance/接触电阻	≤5mΩ	
Insulation resistance/绝缘电阻	≥100MΩ	
Connector body/胶芯	TPU	
Pin/端子	Phosphorus copper with gold plated/磷铜镀金	
Nut and shell/螺母和铜壳	Brass with nickel plated/黄铜镀镍	
Gasket/胶圈	Fluorine ring/氟胶圈	
Black glue/黑色胶水	Epoxy resin/环氧树脂	
Customs tariff number/海关编码	8538900000	
Environmental compliance/环境符合标准	RoHs, Reach	



**M5 female straight rear panel mount connector, unshielded, insert/M5母头直头后锁面板板端, 不带屏蔽**

Scale drawing/尺寸图

Product photo/产品图

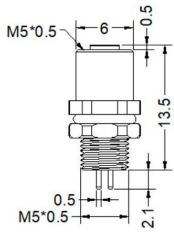

Part number/产品料号

Pins/孔数	Part number/产品料号
3pins/3孔	5B008
4pins/4孔	5B004

Pin assignment front view/针位分布前视图

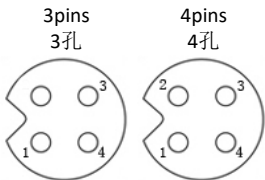

General data/常规数据

Pin numbers/孔数	3pins/3孔	4pins/4孔
Rated voltage/额定电压	60V	
Rated current(40°C)/额定电流	1A	
Standards/标准	IEC 61076-2-105	
Termination/焊接方式	Dip-solder/浸焊	
Connector locking system/锁紧方式	Screw/螺锁	
Degree of protection/防护等级	IP67, IP68, IP69K	
Mechanical operation/插拔次数	>100 mating cycles/大于100次	
Ambient temperature(operation)/操作温度	-25°C~+85°C	
Contact resistance/接触电阻	≤5mΩ	
Insulation resistance/绝缘电阻	≥100MΩ	
Connector body/胶芯	TPU	
Pin/端子	Phosphorus copper with gold plated/磷铜镀金	
Nut and shell/螺母和铜壳	Brass with nickel plated/黄铜镀镍	
Gasket/胶圈	Fluorine ring/氟胶圈	
Black glue/黑色胶水	Epoxy resin/环氧树脂	
Customs tariff number/海关编码	8538900000	
Environmental compliance/环境符合标准	RoHs, Reach	

## M5 male straight front panel mount connector, unshielded, solder/M5公头直头前锁面板焊线式, 不带屏蔽

### Scale drawing/尺寸图

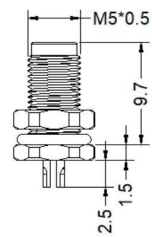

### Product photo/产品图



### Part number/产品料号

Pins/孔数	Part number/产品料号
3pins/3针	5H001
4pins/4针	5H005

### Pin assignment front view/针位分布前视图

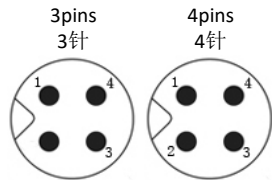

### General data/常规数据

Pin numbers/针数	3pins/3针	4pins/4针
Rated voltage/额定电压	60V	
Rated current(40°C)/额定电流	1A	
Standards/标准	IEC 61076-2-105	
Termination/焊接方式	Solder wires/焊线	
Connector locking system/锁紧方式	Screw/螺锁	
Degree of protection/防护等级	IP67, IP68, IP69K	
Mechanical operation/插拔次数	>100 mating cycles/大于100次	
Ambient temperature(operation)/操作温度	-25°C~+85°C	
Contact resistance/接触电阻	≤5mΩ	
Insulation resistance/绝缘电阻	≥100MΩ	
Connector body/胶芯	TPU	
Pin/端子	Brass with gold plated/黄铜镀金	
Nut and shell/螺母和铜壳	Brass with nickel plated/黄铜镀镍	
Gasket/胶圈	Fluorine ring/氟胶圈	
Black glue/黑色胶水	Epoxy resin/环氧树脂	
Customs tariff number/海关编码	8538900000	
Environmental compliance/环境符合标准	RoHs, Reach	

## M5 male straight rear panel mount connector, unshielded, solder/M5公头直头后锁面板焊线式, 不带屏蔽

Scale drawing/尺寸图

Product photo/产品图

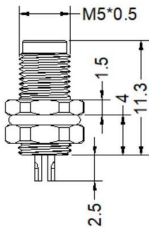

Part number/产品料号

Pins/孔数	Part number/产品料号
3pins/3针	5H002
4pins/4针	5H006

Pin assignment front view/针位分布前视图

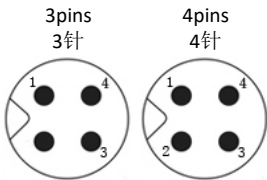

General data/常规数据

Pin numbers/针数	3pins/3针	4pins/4针
Rated voltage/额定电压	60V	
Rated current(40°C)/额定电流	1A	
Standards/标准	IEC 61076-2-105	
Termination/焊接方式	Solder wires/焊线	
Connector locking system/锁紧方式	Screw/螺锁	
Degree of protection/防护等级	IP67, IP68, IP69K	
Mechanical operation/插拔次数	>100 mating cycles/大于100次	
Ambient temperature(operation)/操作温度	-25°C~+85°C	
Contact resistance/接触电阻	≤5mΩ	
Insulation resistance/绝缘电阻	≥100MΩ	
Connector body/胶芯	TPU	
Pin/端子	Brass with gold plated/黄铜镀金	
Nut and shell/螺母和铜壳	Brass with nickel plated/黄铜镀镍	
Gasket/胶圈	Fluorine ring/氟胶圈	
Black glue/黑色胶水	Epoxy resin/环氧树脂	
Customs tariff number/海关编码	8538900000	
Environmental compliance/环境符合标准	RoHs, Reach	

## M5 female straight front panel mount connector, unshielded, solder/M5母头直头前锁面板焊线式, 不带屏蔽

Scale drawing/尺寸图

Product photo/产品图

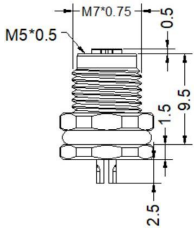

Part number/产品料号

Pins/孔数	Part number/产品料号
3pins/3孔	5H003
4pins/4孔	5H007

Pin assignment front view/针位分布前视图

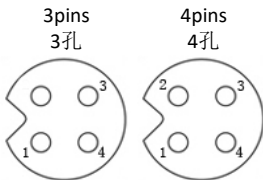

General data/常规数据

Pin numbers/孔数	3pins/3孔	4pins/4孔
Rated voltage/额定电压	60V	
Rated current(40°C)/额定电流	1A	
Standards/标准	IEC 61076-2-105	
Termination/焊接方式	Solder wires/焊线	
Connector locking system/锁紧方式	Screw/螺锁	
Degree of protection/防护等级	IP67, IP68, IP69K	
Mechanical operation/插拔次数	>100 mating cycles/大于100次	
Ambient temperature(operation)/操作温度	-25°C~+85°C	
Contact resistance/接触电阻	≤5mΩ	
Insulation resistance/绝缘电阻	≥100MΩ	
Connector body/胶芯	TPU	
Pin/端子	Phosphorus copper with gold plated/磷铜镀金	
Nut and shell/螺母和铜壳	Brass with nickel plated/黄铜镀镍	
Gasket/胶圈	Fluorine ring/氟胶圈	
Black glue/黑色胶水	Epoxy resin/环氧树脂	
Customs tariff number/海关编码	8538900000	
Environmental compliance/环境符合标准	RoHs, Reach	

## M5 female straight rear panel mount connector, unshielded, solder/M5母头直头后锁面板焊线式, 不带屏蔽

Scale drawing/尺寸图

Product photo/产品图

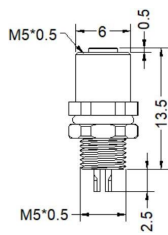

Part number/产品料号

Pins/孔数	Part number/产品料号
3pins/3孔	5H004
4pins/4孔	5H008

Pin assignment front view/针位分布前视图

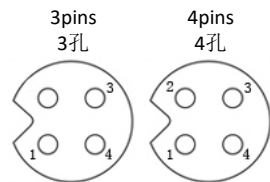

General data/常规数据

Pin numbers/孔数	3pins/3孔	4pins/4孔
Rated voltage/额定电压	60V	
Rated current(40°C)/额定电流	1A	
Standards/标准	IEC 61076-2-105	
Termination/焊接方式	Solder wires/焊线	
Connector locking system/锁紧方式	Screw/螺锁	
Degree of protection/防护等级	IP67, IP68, IP69K	
Mechanical operation/插拔次数	>100 mating cycles/大于100次	
Ambient temperature(operation)/操作温度	-25°C~+85°C	
Contact resistance/接触电阻	≤5mΩ	
Insulation resistance/绝缘电阻	≥100MΩ	
Connector body/胶芯	TPU	
Pin/端子	Phosphorus copper with gold plated/磷铜镀金	
Nut and shell/螺母和铜壳	Brass with nickel plated/黄铜镀镍	
Gasket/胶圈	Fluorine ring/氟胶圈	
Black glue/黑色胶水	Epoxy resin/环氧树脂	
Customs tariff number/海关编码	8538900000	
Environmental compliance/环境符合标准	RoHs, Reach	

## M5 male straight front panel mount connector, unshielded, single wires/M5公头直头前锁面板带线, 不带屏蔽

Scale drawing/尺寸图

Product photo/产品图

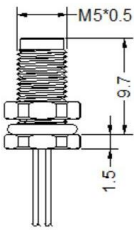

Part number/产品料号

Pins/孔数	Part number("X" is length millimetre mm)/产品料号("X"表示长度, 单位毫米mm)
3pins/3针	5D014-X
4pins/4针	5D001-X

Pin assignment front view/针位分布前视图

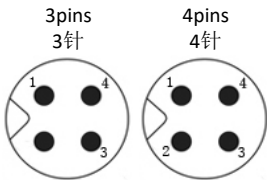

General data/常规数据

Pin numbers/针数	3pins/3针	4pins/4针
Rated voltage/额定电压	60V	
Rated current(40°C)/额定电流	1A	
Standards/标准	IEC 61076-2-105	
Termination/焊接方式	With single wires/带线	
Connector locking system/锁紧方式	Screw/螺锁	
Degree of protection/防护等级	IP67, IP68, IP69K	
Wire gauge(mm²)/线规(平方数)	0.14mm²	
Wire gauge(AWG)/线号(平方数)	26AWG	
Mechanical operation/插拔次数	>100 mating cycles/大于100次	
Ambient temperature(operation)/操作温度	-25°C~+85°C	
Contact resistance/接触电阻	≤5mΩ	
Insulation resistance/绝缘电阻	≥100MΩ	
Connector body/胶芯	TPU	
Pin/端子	Brass with gold plated/黄铜镀金	
Nut and shell/螺母和铜壳	Brass with nickel plated/黄铜镀镍	
Gasket/胶圈	Fluorine ring/氟胶圈	
Black glue/黑色胶水	Epoxy resin/环氧树脂	
Customs tariff number/海关编码	8538900000	
Environmental compliance/环境符合标准	RoHs, Reach	

## M5 male straight rear panel mount connector, unshielded, single wires/M5公头直头后锁面板带线, 不带屏蔽

Scale drawing/尺寸图

Product photo/产品图

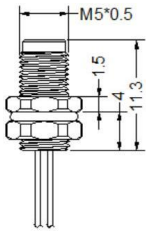

### Part number/产品料号

Pins/孔数	Part number("X" is length millimetre mm)/产品料号("X"表示长度, 单位毫米mm)
3pins/3针	5D006-X
4pins/4针	5D002-X

### Pin assignment front view/针位分布前视图

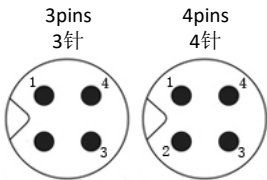

### General data/常规数据

Pin numbers/针数	3pins/3针	4pins/4针
Rated voltage/额定电压	60V	
Rated current(40°C)/额定电流	1A	
Standards/标准	IEC 61076-2-105	
Termination/焊接方式	With single wires/带线	
Connector locking system/锁紧方式	Screw/螺锁	
Degree of protection/防护等级	IP67, IP68, IP69K	
Wire gauge(mm²)/线规(平方数)	0.14mm²	
Wire gauge(AWG)/线号(平方数)	26AWG	
Mechanical operation/插拔次数	>100 mating cycles/大于100次	
Ambient temperature(operation)/操作温度	-25°C~+85°C	
Contact resistance/接触电阻	≤5mΩ	
Insulation resistance/绝缘电阻	≥100MΩ	
Connector body/胶芯	TPU	
Pin/端子	Brass with gold plated/黄铜镀金	
Nut and shell/螺母和铜壳	Brass with nickel plated/黄铜镀镍	
Gasket/胶圈	Fluorine ring/氟胶圈	
Black glue/黑色胶水	Epoxy resin/环氧树脂	
Customs tariff number/海关编码	8538900000	
Environmental compliance/环境符合标准	RoHS, Reach	

## M5 female straight front panel mount connector, unshielded, single wires/M5母头直头前锁面板带线, 不带屏蔽

Scale drawing/尺寸图

Product photo/产品图

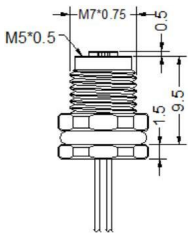

### Part number/产品料号

Pins/孔数	Part number("X" is length millimetre mm)/产品料号("X"表示长度, 单位毫米mm)
3pins/3孔	5D016-X
4pins/4孔	5D003-X

### Pin assignment front view/针位分布前视图

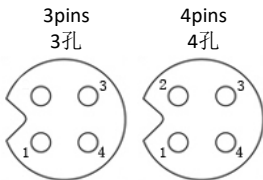

### General data/常规数据

Pin numbers/孔数	3pins/3孔	4pins/4孔
Rated voltage/额定电压	60V	
Rated current(40°C)/额定电流	1A	
Standards/标准	IEC 61076-2-105	
Termination/焊接方式	With single wires/带线	
Connector locking system/锁紧方式	Screw/螺锁	
Degree of protection/防护等级	IP67, IP68, IP69K	
Wire gauge(mm²)/线规(平方数)	0.14mm²	
Wire gauge(AWG)/线号(平方数)	26AWG	
Mechanical operation/插拔次数	>100 mating cycles/大于100次	
Ambient temperature(operation)/操作温度	-25°C~+85°C	
Contact resistance/接触电阻	≤5mΩ	
Insulation resistance/绝缘电阻	≥100MΩ	
Connector body/胶芯	TPU	
Pin/端子	Phosphorus copper with gold plated/磷铜镀金	
Nut and shell/螺母和铜壳	Brass with nickel plated/黄铜镀镍	
Gasket/胶圈	Fluorine ring/氟胶圈	
Black glue/黑色胶水	Epoxy resin/环氧树脂	
Customs tariff number/海关编码	8538900000	
Environmental compliance/环境符合标准	RoHS, Reach	



## M5 female straight rear panel mount connector, unshielded, single wires/M5母头直头后锁面板带线, 不带屏蔽

Scale drawing/尺寸图

Product photo/产品图

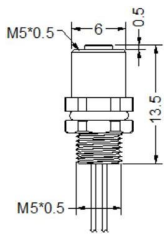

### Part number/产品料号

Pins/孔数	Part number("X" is length millimetre mm)/产品料号("X"表示长度, 单位毫米mm)
3pins/3孔	5D017-X
4pins/4孔	5D004-X

### Pin assignment front view/针位分布前视图

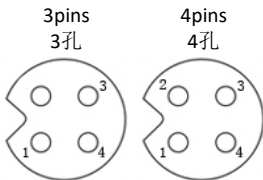

### General data/常规数据

Pin numbers/孔数	3pins/3孔	4pins/4孔
Rated voltage/额定电压	60V	
Rated current(40°C)/额定电流	1A	
Standards/标准	IEC 61076-2-105	
Termination/焊接方式	With single wires/带线	
Connector locking system/锁紧方式	Screw/螺锁	
Degree of protection/防护等级	IP67, IP68, IP69K	
Wire gauge(mm²)/线规(平方数)	0.14mm²	
Wire gauge(AWG)/线号(平方数)	26AWG	
Mechanical operation/插拔次数	>100 mating cycles/大于100次	
Ambient temperature(operation)/操作温度	-25°C~+85°C	
Contact resistance/接触电阻	≤5mΩ	
Insulation resistance/绝缘电阻	≥100MΩ	
Connector body/胶芯	TPU	
Pin/端子	Phosphorus copper with gold plated/磷铜镀金	
Nut and shell/螺母和铜壳	Brass with nickel plated/黄铜镀镍	
Gasket/胶圈	Fluorine ring/氟胶圈	
Black glue/黑色胶水	Epoxy resin/环氧树脂	
Customs tariff number/海关编码	8538900000	
Environmental compliance/环境符合标准	RoHS, Reach	

## M5 male straight cabler, unshielded/M5公头直头连接线, 不带屏蔽

### Scale drawing/尺寸图

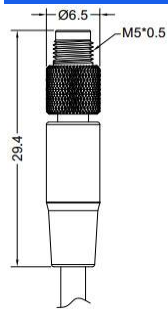

### Product photo/产品图



### Part number/产品料号

Pins/针数	Part number("X" is length millimetre mm)/产品料号("X"表示长度, 单位毫米mm)		
	PVC jacket/PVC外被	PUR jacket/PUR外被	
	-10°C~+80°C	-40°C~+105°C	-40°C~+105°C
3pins/3针	5L015-X	5L011-X	5L017-X
4pins/4针	5L001-X	5L004-X	5L013-X

### Pin assignment front view/针位分布前视图

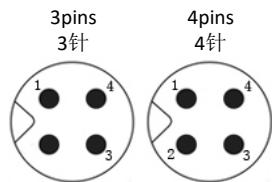

### General data/常规数据

Pin numbers/针数	3pins/3针	4pins/4针
Rated voltage/额定电压	60V	
Rated current(40°C)/额定电流	1A	
Standards/标准	IEC 61076-2-105	
Termination/焊接方式	Solder and over-mold/焊接和成型	
Connector locking system/锁紧方式	Screw/螺锁	
Degree of protection/防护等级	IP67, IP68, IP69K	
Wire gauge(mm²)/线规(平方数)	0.14mm²	
Wire gauge(AWG)/线号(平方数)	26AWG	
Mechanical operation/插拔次数	>100 mating cycles/大于100次	
Ambient temperature(operation)/操作温度	-25°C~+85°C	
Contact resistance/接触电阻	≤5mΩ	
Insulation resistance/绝缘电阻	≥100MΩ	
Connector body/胶芯	TPU	
Pin/端子	Brass with gold plated/黄铜镀金	
Screw/螺丝	Brass with nickel plated/黄铜镀镍	
Over-mold/成型	TPU	
Customs tariff number/海关编码	8518900001	
Environmental compliance/环境符合标准	RoHS, Reach	

## M5 female straight cabler, unshielded/M5母头直头连接线, 不带屏蔽

### Scale drawing/尺寸图

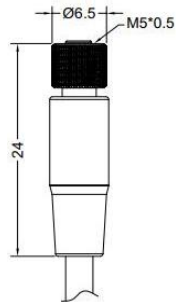

### Product photo/产品图



### Part number/产品料号

Pins/针数	Part number("X" is length millimetre mm)/产品料号("X"表示长度, 单位毫米mm)		
	PVC jacket/PVC外被	PUR jacket/PUR外被	
	-10°C~+80°C	-40°C~+105°C	-40°C~+105°C
3pins/3孔	5L026-X	5L012-X	5L033-X
4pins/4孔	5L027-X	5L005-X	5L014-X

### Pin assignment front view/针位分布前视图

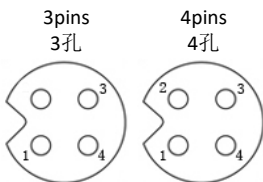

### General data/常规数据

Pin numbers/孔数	3pins/3孔	4pins/4孔
Rated voltage/额定电压	60V	
Rated current(40°C)/额定电流	1A	
Standards/标准	IEC 61076-2-105	
Termination/焊接方式	Solder and over-mold/焊接和成型	
Connector locking system/锁紧方式	Screw/螺锁	
Degree of protection/防护等级	IP67, IP68, IP69K	
Wire gauge(mm²)/线规(平方数)	0.14mm²	
Wire gauge(AWG)/线号(平方数)	26AWG	
Mechanical operation/插拔次数	>100 mating cycles/大于100次	
Ambient temperature(operation)/操作温度	-25°C~+85°C	
Contact resistance/接触电阻	≤5mΩ	
Insulation resistance/绝缘电阻	≥100MΩ	
Connector body/胶芯	TPU	
Pin/端子	Phosphorus copper with gold plated/磷铜镀金	
Screw/螺丝	Brass with nickel plated/黄铜镀镍	
Over-mold/成型	TPU	
Gasket/胶圈	Fluorine ring/氟胶圈	
Customs tariff number/海关编码	8518900001	
Environmental compliance/环境符合标准	RoHs, Reach	

## M5 male right angle cable, unshielded/M5公头弯头连接线, 不带屏蔽

Scale drawing/尺寸图

Product photo/产品图

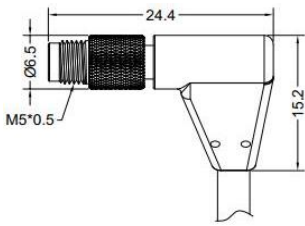

### Part number/产品料号

Pins/针数	Part number("X" is length millimetre mm)/产品料号("X"表示长度, 单位毫米mm)		
	PVC jacket/PVC外被	PUR jacket/PUR外被	
	-10°C~+80°C	-40°C~+105°C	-40°C~+105°C
3pins/3针	5L034-X	5L275-X	5L039-X
4pins/4针	5L006-X	5L008-X	5L037-X

### Pin assignment front view/针位分布前视图

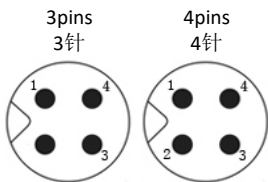

### General data/常规数据

Pin numbers/针数	3pins/3针	4pins/4针
Rated voltage/额定电压	60V	
Rated current(40°C)/额定电流	1A	
Standards/标准	IEC 61076-2-105	
Termination/焊接方式	Solder and over-mold/焊接和成型	
Connector locking system/锁紧方式	Screw/螺锁	
Degree of protection/防护等级	IP67, IP68, IP69K	
Wire gauge(mm²)/线规(平方数)	0.14mm²	
Wire gauge(AWG)/线号(平方数)	26AWG	
Mechanical operation/插拔次数	>100 mating cycles/大于100次	
Ambient temperature(operation)/操作温度	-25°C~+85°C	
Contact resistance/接触电阻	≤5mΩ	
Insulation resistance/绝缘电阻	≥100MΩ	
Connector body/胶芯	TPU	
Pin/端子	Brass with gold plated/黄铜镀金	
Screw/螺丝	Brass with nickel plated/黄铜镀镍	
Over-mold/成型	TPU	
Customs tariff number/海关编码	8518900001	
Environmental compliance/环境符合标准	RoHS, Reach	

## M5 female right angle cable, unshielded/M5母头弯头连接线, 不带屏蔽

Scale drawing/尺寸图

Product photo/产品图

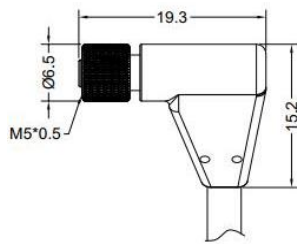

Part number/产品料号

Pins/针数	Part number("X" is length millimetre mm)/产品料号("X"表示长度, 单位毫米mm)		
	PVC jacket/PVC外被	PUR jacket/PUR外被	
	-10°C~+80°C	-40°C~+105°C	-40°C~+105°C
3pins/3孔	5L028-X	5L021-X	5L040-X
4pins/4孔	5L007-X	5L009-X	5L038-X

Pin assignment front view/针位分布前视图

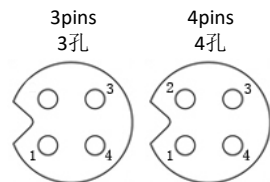

General data/常规数据

Pin numbers/孔数	3pins/3孔	4pins/4孔
Rated voltage/额定电压	60V	
Rated current(40°C)/额定电流	1A	
Standards/标准	IEC 61076-2-105	
Termination/焊接方式	Solder and over-mold/焊接和成型	
Connector locking system/锁紧方式	Screw/螺锁	
Degree of protection/防护等级	IP67, IP68, IP69K	
Wire gauge(mm²)/线规(平方数)	0.14mm²	
Wire gauge(AWG)/线号(平方数)	26AWG	
Mechanical operation/插拔次数	>100 mating cycles/大于100次	
Ambient temperature(operation)/操作温度	-25°C~+85°C	
Contact resistance/接触电阻	≤5mΩ	
Insulation resistance/绝缘电阻	≥100MΩ	
Connector body/胶芯	TPU	
Pin/端子	Phosphorus copper with gold plated/磷铜镀金	
Screw/螺丝	Brass with nickel plated/黄铜镀镍	
Over-mold/成型	TPU	
Gasket/胶圈	Fluorine ring/氟胶圈	
Customs tariff number/海关编码	8518900001	
Environmental compliance/环境符合标准	RoHs, Reach	

## M5 male straight cabler, shielded/M5公头直头连接线, 带屏蔽

### Scale drawing/尺寸图

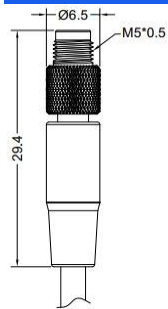

### Product photo/产品图



### Part number/产品料号

Pins/针数	Part number("X" is length millimetre mm)/产品料号("X"表示长度, 单位毫米mm)		
	PVC jacket/PVC外被	PUR jacket/PUR外被	
	-10°C~+80°C	-40°C~+105°C	-40°C~+105°C
3pins/3针	5L047-X	5L048-X	5L049-X
4pins/4针	5L023-X	5L059-X	5L060-X

### Pin assignment front view/针位分布前视图

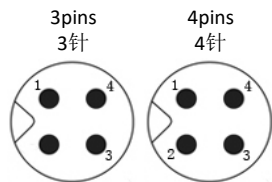

### General data/常规数据

Pin numbers/针数	3pins/3针	4pins/4针
Rated voltage/额定电压	60V	
Rated current(40°C)/额定电流	1A	
Standards/标准	IEC 61076-2-105	
Termination/焊接方式	Solder and over-mold/焊接和成型	
Connector locking system/锁紧方式	Screw/螺锁	
Degree of protection/防护等级	IP67, IP68, IP69K	
Wire gauge(mm²)/线规(平方数)	0.14mm²	
Wire gauge(AWG)/线号(平方数)	26AWG	
Mechanical operation/插拔次数	>100 mating cycles/大于100次	
Ambient temperature(operation)/操作温度	-25°C~+85°C	
Contact resistance/接触电阻	≤5mΩ	
Insulation resistance/绝缘电阻	≥100MΩ	
Connector body/胶芯	TPU	
Pin/端子	Brass with gold plated/黄铜镀金	
Screw/螺丝	Brass with nickel plated/黄铜镀镍	
Over-mold/成型	TPU	
Shielded sheath/屏蔽罩	Brass with nickel plated/黄铜镀镍	
Customs tariff number/海关编码	8518900001	
Environmental compliance/环境符合标准	RoHs, Reach	

## M5 female straight cabler, shielded/M5母头直头连接线, 带屏蔽

### Scale drawing/尺寸图

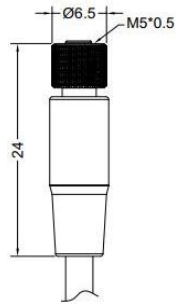

### Product photo/产品图



### Part number/产品料号

Pins/针数	Part number("X" is length millimetre mm)/产品料号("X"表示长度, 单位毫米mm)		
	PVC jacket/PVC外被	PUR jacket/PUR外被	
	-10°C~+80°C	-40°C~+105°C	-40°C~+105°C
3pins/3孔	5L050-X	5L051-X	5L052-X
4pins/4孔	5L061-X	5L062-X	5L063-X

### Pin assignment front view/针位分布前视图

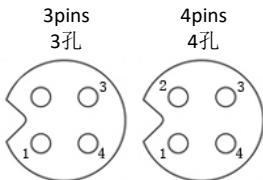

### General data/常规数据

Pin numbers/孔数	3pins/3孔	4pins/4孔
Rated voltage/额定电压	60V	
Rated current(40°C)/额定电流	1A	
Standards/标准	IEC 61076-2-105	
Termination/焊接方式	Solder and over-mold/焊接和成型	
Connector locking system/锁紧方式	Screw/螺锁	
Degree of protection/防护等级	IP67, IP68, IP69K	
Wire gauge(mm²)/线规(平方数)	0.14mm²	
Wire gauge(AWG)/线号(平方数)	26AWG	
Mechanical operation/插拔次数	>100 mating cycles/大于100次	
Ambient temperature(operation)/操作温度	-25°C~+85°C	
Contact resistance/接触电阻	≤5mΩ	
Insulation resistance/绝缘电阻	≥100MΩ	
Connector body/胶芯	TPU	
Pin/端子	Phosphorus copper with gold plated/磷铜镀金	
Screw/螺丝	Brass with nickel plated/黄铜镀镍	
Over-mold/成型	TPU	
Shielded sheath/屏蔽罩	Brass with nickel plated/黄铜镀镍	
Gasket/胶圈	Fluorine ring/氟胶圈	
Customs tariff number/海关编码	8518900001	
Environmental compliance/环境符合标准	RoHS, Reach	

## M5 male right angle cable, shielded/M5公头弯头连接线, 带屏蔽

Scale drawing/尺寸图

Product photo/产品图

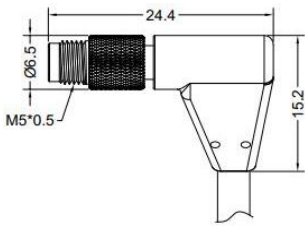

Part number/产品料号

Pins/针数	Part number("X" is length millimetre mm)/产品料号("X"表示长度, 单位毫米mm)		
	PVC jacket/PVC外被	PUR jacket/PUR外被	
	-10°C~+80°C	-40°C~+105°C	-40°C~+105°C
3pins/3针	5L053-X	5L054-X	5L055-X
4pins/4针	5L064-X	5L065-X	5L066-X

Pin assignment front view/针位分布前视图

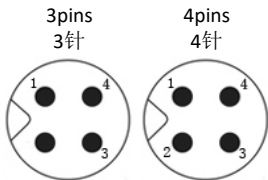

General data/常规数据

Pin numbers/针数	3pins/3针	4pins/4针
Rated voltage/额定电压	60V	
Rated current(40°C)/额定电流	1A	
Standards/标准	IEC 61076-2-105	
Termination/焊接方式	Solder and over-mold/焊接和成型	
Connector locking system/锁紧方式	Screw/螺锁	
Degree of protection/防护等级	IP67, IP68, IP69K	
Wire gauge(mm²)/线规(平方数)	0.14mm²	
Wire gauge(AWG)/线号(平方数)	26AWG	
Mechanical operation/插拔次数	>100 mating cycles/大于100次	
Ambient temperature(operation)/操作温度	-25°C~+85°C	
Contact resistance/接触电阻	≤5mΩ	
Insulation resistance/绝缘电阻	≥100MΩ	
Connector body/胶芯	TPU	
Pin/端子	Brass with gold plated/黄铜镀金	
Screw/螺丝	Brass with nickel plated/黄铜镀镍	
Over-mold/成型	TPU	
Shielded sheath/屏蔽罩	Brass with nickel plated/黄铜镀镍	
Customs tariff number/海关编码	8518900001	
Environmental compliance/环境符合标准	RoHs, Reach	



## M5 female right angle cable, shielded/M5母头弯头连接线, 带屏蔽

Scale drawing/尺寸图

Product photo/产品图

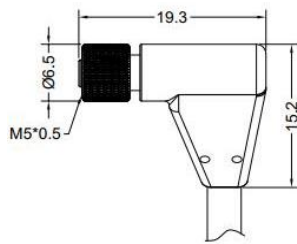

Part number/产品料号

Pins/针数	Part number("X" is length millimetre mm)/产品料号("X"表示长度, 单位毫米mm)		
	PVC jacket/PVC外被	PUR jacket/PUR外被	
	-10°C~+80°C	-40°C~+105°C	-40°C~+105°C
3pins/3孔	5L056-X	5L057-X	5L058-X
4pins/4孔	5L067-X	5L068-X	5L069-X

Pin assignment front view/针位分布前视图

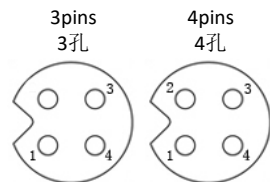

General data/常规数据

Pin numbers/孔数	3pins/3孔	4pins/4孔
Rated voltage/额定电压	60V	
Rated current(40°C)/额定电流	1A	
Standards/标准	IEC 61076-2-105	
Termination/焊接方式	Solder and over-mold/焊接和成型	
Connector locking system/锁紧方式	Screw/螺锁	
Degree of protection/防护等级	IP67, IP68, IP69K	
Wire gauge(mm²)/线规(平方数)	0.14mm²	
Wire gauge(AWG)/线号(平方数)	26AWG	
Mechanical operation/插拔次数	>100 mating cycles/大于100次	
Ambient temperature(operation)/操作温度	-25°C~+85°C	
Contact resistance/接触电阻	≤5mΩ	
Insulation resistance/绝缘电阻	≥100MΩ	
Connector body/胶芯	TPU	
Pin/端子	Phosphorus copper with gold plated/磷铜镀金	
Screw/螺丝	Brass with nickel plated/黄铜镀镍	
Over-mold/成型	TPU	
Shielded sheath/屏蔽罩	Brass with nickel plated/黄铜镀镍	
Gasket/胶圈	Fluorine ring/氟胶圈	
Customs tariff number/海关编码	8518900001	
Environmental compliance/环境符合标准	RoHS, Reach	

## M5 male to male right angle cable, unshielded/M5公头弯头对公头弯头连接线, 不带屏蔽

### Scale drawing/尺寸图

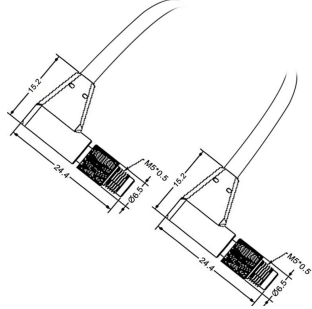

### Product photo/产品图



### Part number/产品料号

Pins/针数	Part number("X" is length millimetre mm)/产品料号("X"表示长度, 单位毫米mm)		
	PVC jacket/PVC外被	PUR jacket/PUR外被	
	-10°C~+80°C	-40°C~+105°C	-40°C~+105°C
3pins/3针	5L096-X	5L097-X	5L098-X
4pins/4针	5L108-X	5L109-X	5L110-X

### Pin assignment front view/针位分布前视图

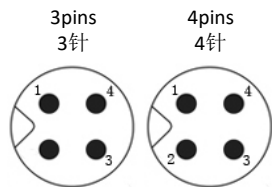

### General data/常规数据

Pin numbers/针数	3pins/3针	4pins/4针
Rated voltage/额定电压	60V	
Rated current(40°C)/额定电流	1A	
Standards/标准	IEC 61076-2-105	
Termination/焊接方式	Solder and over-mold/焊接和成型	
Connector locking system/锁紧方式	Screw/螺锁	
Degree of protection/防护等级	IP67, IP68, IP69K	
Wire gauge(mm²)/线规(平方数)	0.14mm²	
Wire gauge(AWG)/线号(平方数)	26AWG	
Mechanical operation/插拔次数	>100 mating cycles/大于100次	
Ambient temperature(operation)/操作温度	-25°C~+85°C	
Contact resistance/接触电阻	≤5mΩ	
Insulation resistance/绝缘电阻	≥100MΩ	
Connector body/胶芯	TPU	
pins/端子	Brass with gold plated/黄铜镀金	
Screw/螺丝	Brass with nickel plated/黄铜镀镍	
Over-mold/成型	TPU	
Gasket/胶圈	Fluorine ring/氟胶圈	
Customs tariff number/海关编码	8518900001	
Environmental compliance/环境符合标准	RoHs, Reach	

## M5 male to female right angle cable, unshielded/M5公头弯头对母弯头连接线, 不带屏蔽

### Scale drawing/尺寸图

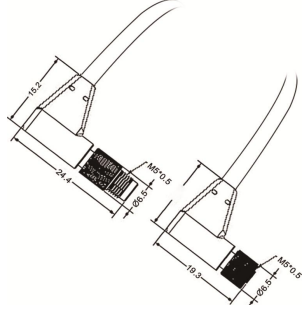

### Product photo/产品图



### Part number/产品料号

Pins/针数	Part number("X" is length millimetre mm)/产品料号("X"表示长度, 单位毫米mm)		
	PVC jacket/PVC外被	PUR jacket/PUR外被	
	-10°C~+80°C	-40°C~+105°C	-40°C~+105°C
3pins/3孔	5L075-X	5L076-X	5L077-X
4pins/4孔	5L078-X	5L079-X	5L080-X

### Pin assignment front view/针位分布前视图

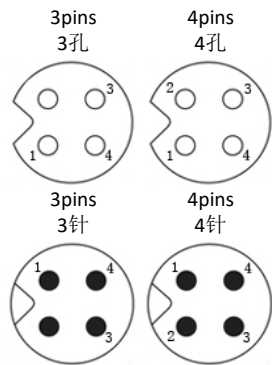

### General data/常规数据

Pin numbers/孔数	3pins/3孔	4pins/4孔
Rated voltage/额定电压	60V	
Rated current(40°C)/额定电流	1A	
Standards/标准	IEC 61076-2-105	
Termination/焊接方式	Solder and over-mold/焊接和成型	
Connector locking system/锁紧方式	Screw/锁紧	
Degree of protection/防护等级	IP67, IP68, IP69K	
Wire gauge(mm²)/线规(平方数)	0.14mm²	
Wire gauge(AWG)/线号(平方数)	26AWG	
Mechanical operation/插拔次数	>100 mating cycles/大于100次	
Ambient temperature(operation)/操作温度	-25°C~+85°C	
Contact resistance/接触电阻	≤5mΩ	
Insulation resistance/绝缘电阻	≥100MΩ	
Connector body/胶芯	TPU	
Male pin/公端子	Brass with gold plated/黄铜镀金	
Female pin/母端子	Phosphorus copper with gold plated/磷铜镀金	
Screw/螺丝	Brass with nickel plated/黄铜镀镍	
Over-mold/成型	TPU	
Gasket/胶圈	Fluorine ring/氟胶圈	
Customs tariff number/海关编码	8518900001	
Environmental compliance/环境符合标准	RoHS, Reach	



## M5 code male straight to male right angle molded cable,unshielded/M5, 公头直头对公头弯头连接线, 不带屏蔽

### Scale drawing/尺寸图

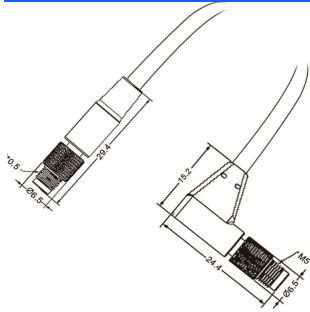

### Product photo/产品图



### Part number/产品料号

Pins/针数	Part number("X" is length millimetre mm)/产品料号("X"表示长度, 单位毫米mm)		
	PVC jacket/PVC外被	PUR jacket/PUR外被	
	-10°C~+80°C	-40°C~+105°C	-40°C~+105°C
3pins/3针	5L204-X	5L205-X	5L206-X
4pins/4针	5L207-X	5L208-X	5L209-X

### Pin assignment front view/针位分布前视图

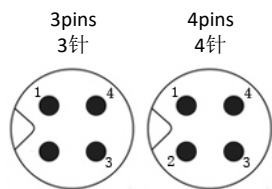

### General data/常规数据

Pin numbers/针数	3pins/3针	4pins/4针
Rated voltage/额定电压	60V	
Rated current(40°C)/额定电流	1A	
Standards/标准	IEC 61076-2-105	
Termination/焊接方式	Solder and over-mold/焊接和成型	
Connector locking system/锁紧方式	Screw/螺锁	
Degree of protection/防护等级	IP67, IP68, IP69K	
Wire gauge(mm²)/线规(平方数)	0.14mm²	
Wire gauge(AWG)/线号(平方数)	26AWG	
Mechanical operation/插拔次数	>100 mating cycles/大于100次	
Ambient temperature(operation)/操作温度	-25°C~+85°C	
Contact resistance/接触电阻	≤5mΩ	
Insulation resistance/绝缘电阻	≥100MΩ	
Connector body/胶芯	TPU	
pins/端子	Brass with gold plated/黄铜镀金	
Screw/螺丝	Brass with nickel plated/黄铜镀镍	
Over-mold/成型	TPU	
Gasket/胶圈	Fluorine ring/氟胶圈	
Customs tariff number/海关编码	8518900001	
Environmental compliance/环境符合标准	RoHs, Reach	

## M5 male to male straight cable, unshielded/M5公头直头对公直头连接线, 不带屏蔽

### Scale drawing/尺寸图

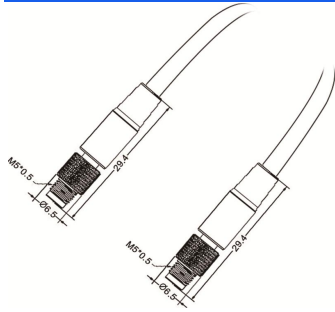

### Product photo/产品图



### Part number/产品料号

Pins/针数	Part number("X" is length millimetre mm)/产品料号("X"表示长度, 单位毫米mm)		
	PVC jacket/PVC外被	PUR jacket/PUR外被	
	-10°C~+80°C	-40°C~+105°C	-40°C~+105°C
3pins/3针	5L093-X	5L094-X	5L095-X
4pins/4针	5L045-X	5L106-X	5L107-X

### Pin assignment front view/针位分布前视图

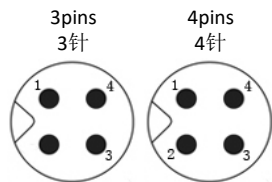

### General data/常规数据

Pin numbers/针数	3pins/3针	4pins/4针
Rated voltage/额定电压	60V	
Rated current(40°C)/额定电流	1A	
Standards/标准	IEC 61076-2-105	
Termination/焊接方式	Solder and over-mold/焊接和成型	
Connector locking system/锁紧方式	Screw/螺锁	
Degree of protection/防护等级	IP67, IP68, IP69K	
Wire gauge(mm²)/线规(平方数)	0.14mm²	
Wire gauge(AWG)/线号(平方数)	26AWG	
Mechanical operation/插拔次数	>100 mating cycles/大于100次	
Ambient temperature(operation)/操作温度	-25°C~+85°C	
Contact resistance/接触电阻	≤5mΩ	
Insulation resistance/绝缘电阻	≥100MΩ	
Connector body/胶芯	TPU	
pins/端子	Brass with gold plated/黄铜镀金	
Screw/螺丝	Brass with nickel plated/黄铜镀镍	
Over-mold/成型	TPU	
Gasket/胶圈	Fluorine ring/氟胶圈	
Customs tariff number/海关编码	8518900001	
Environmental compliance/环境符合标准	RoHs, Reach	

## M5 male straight to female right angle cable, unshielded/M5公头直头对母头弯头连接线, 不带屏蔽

### Scale drawing/尺寸图

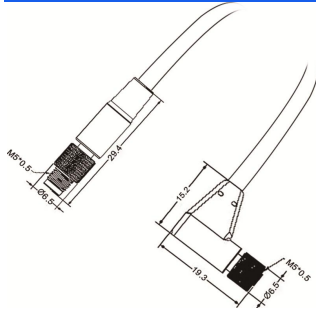

### Product photo/产品图



### Part number/产品料号

Pins/针数	Part number("X" is length millimetre mm)/产品料号("X"表示长度, 单位毫米mm)		
	PVC jacket/PVC外被	PUR jacket/PUR外被	
	-10°C~+80°C	-40°C~+105°C	-40°C~+105°C
3pins/3孔	5L083-X	5L084-X	5L085-X
4pins/4孔	5L022-X	5L081-X	5L082-X

### Pin assignment front view/针位分布前视图

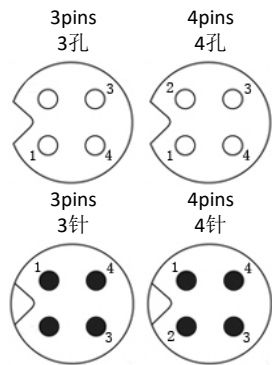

### General data/常规数据

Pin numbers/孔数	3pins/3孔	4pins/4孔
Rated voltage/额定电压	60V	
Rated current(40°C)/额定电流	1A	
Standards/标准	IEC 61076-2-105	
Termination/焊接方式	Solder and over-mold/焊接和成型	
Connector locking system/锁紧方式	Screw/锁紧	
Degree of protection/防护等级	IP67, IP68, IP69K	
Wire gauge(mm²)/线规(平方数)	0.14mm²	
Wire gauge(AWG)/线号(平方数)	26AWG	
Mechanical operation/插拔次数	>100 mating cycles/大于100次	
Ambient temperature(operation)/操作温度	-25°C~+85°C	
Contact resistance/接触电阻	≤5mΩ	
Insulation resistance/绝缘电阻	≥100MΩ	
Connector body/胶芯	TPU	
Male pin/公端子	Brass with gold plated/黄铜镀金	
Female pin/母端子	Phosphorus copper with gold plated/磷铜镀金	
Screw/螺丝	Brass with nickel plated/黄铜镀镍	
Over-mold/成型	TPU	
Gasket/胶圈	Fluorine ring/氟胶圈	
Customs tariff number/海关编码	8518900001	
Environmental compliance/环境符合标准	RoHS, Reach	



## M5 male to female straight cable, unshielded/M5公头直头对母头直头连接线, 不带屏蔽

### Scale drawing/尺寸图

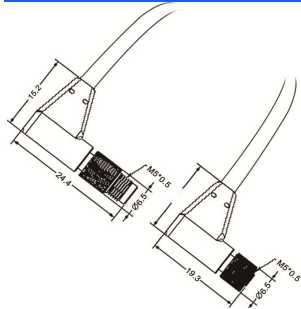

### Product photo/产品图



### Part number/产品料号

Pins/针数	Part number("X" is length millimetre mm)/产品料号("X"表示长度, 单位毫米mm)		
	PVC jacket/PVC外被	PUR jacket/PUR外被	
	-10°C~+80°C	-40°C~+105°C	-40°C~+105°C
3pins/3孔	5L072-X	5L073-X	5L074-X
4pins/4孔	5L070-X	5L018-X	5L071-X

### Pin assignment front view/针位分布前视图

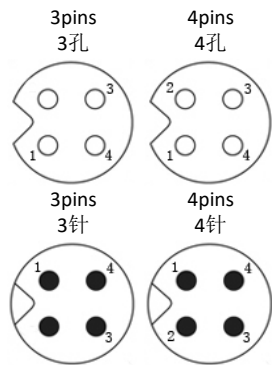

### General data/常规数据

Pin numbers/孔数	3pins/3孔	4pins/4孔
Rated voltage/额定电压	60V	
Rated current(40°C)/额定电流	1A	
Standards/标准	IEC 61076-2-105	
Termination/焊接方式	Solder and over-mold/焊接和成型	
Connector locking system/锁紧方式	Screw/锁紧	
Degree of protection/防护等级	IP67, IP68, IP69K	
Wire gauge(mm²)/线规(平方数)	0.14mm²	
Wire gauge(AWG)/线号(平方数)	26AWG	
Mechanical operation/插拔次数	>100 mating cycles/大于100次	
Ambient temperature(operation)/操作温度	-25°C~+85°C	
Contact resistance/接触电阻	≤5mΩ	
Insulation resistance/绝缘电阻	≥100MΩ	
Connector body/胶芯	TPU	
Male pin/公端子	Brass with gold plated/黄铜镀金	
Female pin/母端子	Phosphorus copper with gold plated/磷铜镀金	
Screw/螺丝	Brass with nickel plated/黄铜镀镍	
Over-mold/成型	TPU	
Gasket/胶圈	Fluorine ring/氟胶圈	
Customs tariff number/海关编码	8518900001	
Environmental compliance/环境符合标准	RoHS, Reach	



## M5 female to female right angle cable, unshielded/M5母头弯头对母弯头连接线, 不带屏蔽

### Scale drawing/尺寸图

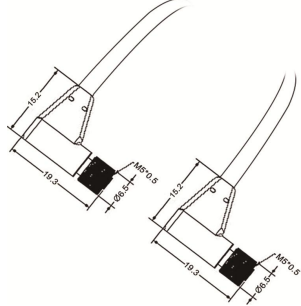

### Product photo/产品图



### Part number/产品料号

Pins/针数	Part number("X" is length millimetre mm)/产品料号("X"表示长度, 单位毫米mm)		
	PVC jacket/PVC外被	PUR jacket/PUR外被	
	-10°C~+80°C	-40°C~+105°C	-40°C~+105°C
3pins/3孔	5L102-X	5L103-X	5L104-X
4pins/4孔	5L114-X	5L115-X	5L116-X

### Pin assignment front view/针位分布前视图

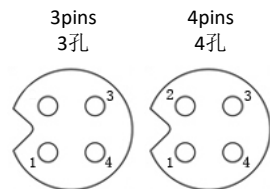

### General data/常规数据

Pin numbers/孔数	3pins/3孔	4pins/4孔
Rated voltage/额定电压	60V	
Rated current(40°C)/额定电流	1A	
Standards/标准	IEC 61076-2-105	
Termination/焊接方式	Solder and over-mold/焊接和成型	
Connector locking system/锁紧方式	Screw/螺锁	
Degree of protection/防护等级	IP67, IP68, IP69K	
Wire gauge(mm²)/线规(平方数)	0.14mm²	
Wire gauge(AWG)/线号(平方数)	26AWG	
Mechanical operation/插拔次数	>100 mating cycles/大于100次	
Ambient temperature(operation)/操作温度	-25°C~+85°C	
Contact resistance/接触电阻	≤5mΩ	
Insulation resistance/绝缘电阻	≥100MΩ	
Connector body/胶芯	TPU	
pins/端子	Brass with gold plated/磷铜镀金	
Screw/螺丝	Brass with nickel plated/黄铜镀镍	
Over-mold/成型	TPU	
Gasket/胶圈	Fluorine ring/氟胶圈	
Customs tariff number/海关编码	8518900001	
Environmental compliance/环境符合标准	RoHs, Reach	

## M5 code female straight to female right angle molded cable,unshielded/M5, 母头直头对母头弯头连接线, 不带屏蔽

### Scale drawing/尺寸图

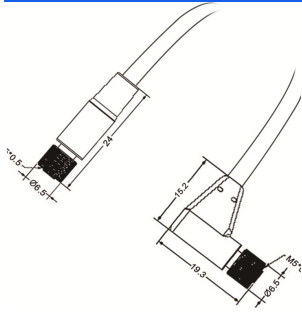

### Product photo/产品图



### Part number/产品料号

Pins/针数	Part number("X" is length millimetre mm)/产品料号("X"表示长度, 单位毫米mm)		
	PVC jacket/PVC外被	PUR jacket/PUR外被	
	-10°C~+80°C	-40°C~+105°C	-40°C~+105°C
3pins/3孔	5L102-X	5L103-X	5L104-X
4pins/4孔	5L114-X	5L115-X	5L116-X

### Pin assignment front view/针位分布前视图

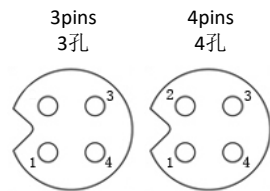

### General data/常规数据

Pin numbers/孔数	3pins/3孔	4pins/4孔
Rated voltage/额定电压	60V	
Rated current(40°C)/额定电流	1A	
Standards/标准	IEC 61076-2-105	
Termination/焊接方式	Solder and over-mold/焊接和成型	
Connector locking system/锁紧方式	Screw/螺锁	
Degree of protection/防护等级	IP67, IP68, IP69K	
Wire gauge(mm²)/线规(平方数)	0.14mm²	
Wire gauge(AWG)/线号(平方数)	26AWG	
Mechanical operation/插拔次数	>100 mating cycles/大于100次	
Ambient temperature(operation)/操作温度	-25°C~+85°C	
Contact resistance/接触电阻	≤5mΩ	
Insulation resistance/绝缘电阻	≥100MΩ	
Connector body/胶芯	TPU	
pins/端子	Brass with gold plated/磷铜镀金	
Screw/螺丝	Brass with nickel plated/黄铜镀镍	
Over-mold/成型	TPU	
Gasket/胶圈	Fluorine ring/氟胶圈	
Customs tariff number/海关编码	8518900001	
Environmental compliance/环境符合标准	RoHs, Reach	

## M5 female to female straight cable, unshielded/M5母头直头对母直头连接线, 不带屏蔽

### Scale drawing/尺寸图

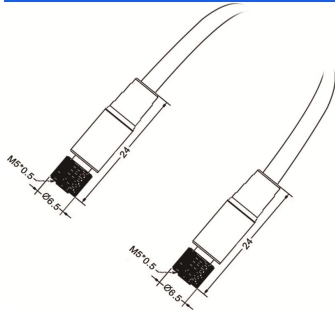

### Product photo/产品图



### Part number/产品料号

Pins/针数	Part number("X" is length millimetre mm)/产品料号("X"表示长度, 单位毫米mm)		
	PVC jacket/PVC外被	PUR jacket/PUR外被	
	-10°C~+80°C	-40°C~+105°C	-40°C~+105°C
3pins/3孔	5L099-X	5L100-X	5L101-X
4pins/4孔	5L111-X	5L112-X	5L113-X

### Pin assignment front view/针位分布前视图

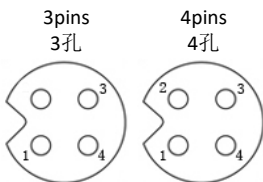

### General data/常规数据

Pin numbers/孔数	3pins/3孔	4pins/4孔
Rated voltage/额定电压	60V	
Rated current(40°C)/额定电流	1A	
Standards/标准	IEC 61076-2-105	
Termination/焊接方式	Solder and over-mold/焊接和成型	
Connector locking system/锁紧方式	Screw/螺锁	
Degree of protection/防护等级	IP67, IP68, IP69K	
Wire gauge(mm²)/线规(平方数)	0.14mm²	
Wire gauge(AWG)/线号(平方数)	26AWG	
Mechanical operation/插拔次数	>100 mating cycles/大于100次	
Ambient temperature(operation)/操作温度	-25°C~+85°C	
Contact resistance/接触电阻	≤5mΩ	
Insulation resistance/绝缘电阻	≥100MΩ	
Connector body/胶芯	TPU	
pins/端子	Phosphorus copper with gold plated/磷铜镀金	
Screw/螺丝	Brass with nickel plated/黄铜镀镍	
Over-mold/成型	TPU	
Gasket/胶圈	Fluorine ring/氟胶圈	
Customs tariff number/海关编码	8518900001	
Environmental compliance/环境符合标准	RoHs, Reach	

## M5 male to male right angle cable, shielded/M5公头弯头对公头弯头连接线, 带屏蔽

### Scale drawing/尺寸图

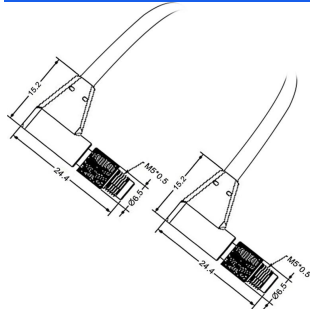

### Product photo/产品图



### Part number/产品料号

Pins/针数	Part number("X" is length millimetre mm)/产品料号("X"表示长度, 单位毫米mm)		
	PVC jacket/PVC外被	PUR jacket/PUR外被	
	-10°C~+80°C	-40°C~+105°C	-40°C~+105°C
3pins/3针	5L241-X	5L242-X	5L243-X
4pins/4针	5L252-X	5L253-X	5L254-X

### Pin assignment front view/针位分布前视图

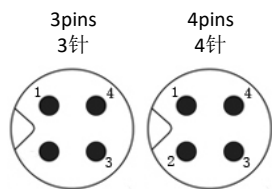

### General data/常规数据

Pin numbers/针数	3pins/3针	4pins/4针
Rated voltage/额定电压	60V	
Rated current(40°C)/额定电流	1A	
Standards/标准	IEC 61076-2-105	
Termination/焊接方式	Solder and over-mold/焊接和成型	
Connector locking system/锁紧方式	Screw/螺锁	
Degree of protection/防护等级	IP67, IP68, IP69K	
Wire gauge(mm²)/线规(平方数)	0.14mm²	
Wire gauge(AWG)/线号(平方数)	26AWG	
Mechanical operation/插拔次数	>100 mating cycles/大于100次	
Ambient temperature(operation)/操作温度	-25°C~+85°C	
Contact resistance/接触电阻	≤5mΩ	
Insulation resistance/绝缘电阻	≥100MΩ	
Connector body/胶芯	TPU	
pins/端子	Brass with gold plated/黄铜镀金	
Screw/螺丝	Brass with nickel plated/黄铜镀镍	
Over-mold/成型	TPU	
Shielded sheath/屏蔽罩	Brass with nickel plated/黄铜镀镍	
Gasket/胶圈	Fluorine ring/氟胶圈	
Customs tariff number/海关编码	8518900001	
Environmental compliance/环境符合标准	RoHS, Reach	

## M5 male to female right angle cable, shielded/M5公头弯头对母弯头连接线, 带屏蔽

### Scale drawing/尺寸图

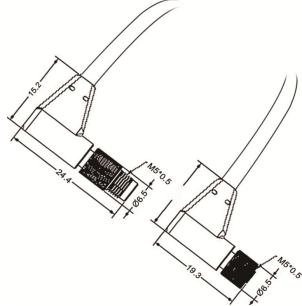

### Product photo/产品图



### Part number/产品料号

Pins/针数	Part number("X" is length millimetre mm)/产品料号("X"表示长度, 单位毫米mm)		
	PVC jacket/PVC外被	PUR jacket/PUR外被	
	-10°C~+80°C	-40°C~+105°C	-40°C~+105°C
3pins/3孔	5L222V	5L223-X	5L224-X
4pins/4孔	5L225-X	5L226-X	5L092-X

### Pin assignment front view/针位分布前视图

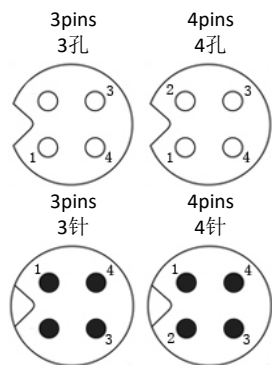

### General data/常规数据

Pin numbers/孔数	3pins/3孔	4pins/4孔
Rated voltage/额定电压	60V	
Rated current(40°C)/额定电流	1A	
Standards/标准	IEC 61076-2-105	
Termination/焊接方式	Solder and over-mold/焊接和成型	
Connector locking system/锁紧方式	Screw/锁紧	
Degree of protection/防护等级	IP67, IP68, IP69K	
Wire gauge(mm²)/线规(平方数)	0.14mm²	
Wire gauge(AWG)/线号(平方数)	26AWG	
Mechanical operation/插拔次数	>100 mating cycles/大于100次	
Ambient temperature(operation)/操作温度	-25°C~+85°C	
Contact resistance/接触电阻	≤5mΩ	
Insulation resistance/绝缘电阻	≥100MΩ	
Connector body/胶芯	TPU	
Male pin/公端子	Brass with gold plated/黄铜镀金	
Female pin/母端子	Phosphorus copper with gold plated/磷铜镀金	
Screw/螺丝	Brass with nickel plated/黄铜镀镍	
Over-mold/成型	TPU	
Shielded sheath/屏蔽罩	Brass with nickel plated/黄铜镀镍	
Gasket/胶圈	Fluorine ring/氟胶圈	
Customs tariff number/海关编码	8518900001	
Environmental compliance/环境符合标准	RoHs, Reach	



## M5 code male straight to male right angle molded cable, shielded/M5, 公头直头对公头弯头连接线, 带屏蔽

### Scale drawing/尺寸图

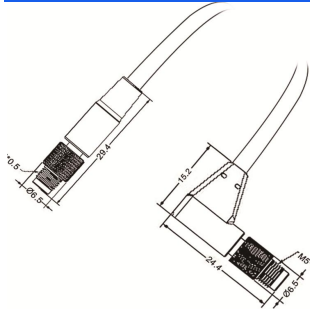

### Product photo/产品图



### Part number/产品料号

Pins/针数	Part number("X" is length millimetre mm)/产品料号("X"表示长度, 单位毫米mm)		
	PVC jacket/PVC外被	PUR jacket/PUR外被	
	-10°C~+80°C	-40°C~+105°C	-40°C~+105°C
3pins/3针	5L261-X	5L262-X	5L263-X
4pins/4针	5L264-X	5L265-X	5L266-X

### Pin assignment front view/针位分布前视图

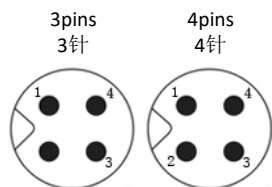

### General data/常规数据

Pin numbers/针数	3pins/3针	4pins/4针
Rated voltage/额定电压	60V	
Rated current(40°C)/额定电流	1A	
Standards/标准	IEC 61076-2-105	
Termination/焊接方式	Solder and over-mold/焊接和成型	
Connector locking system/锁紧方式	Screw/螺锁	
Degree of protection/防护等级	IP67, IP68, IP69K	
Wire gauge(mm²)/线规(平方数)	0.14mm²	
Wire gauge(AWG)/线号(平方数)	26AWG	
Mechanical operation/插拔次数	>100 mating cycles/大于100次	
Ambient temperature(operation)/操作温度	-25°C~+85°C	
Contact resistance/接触电阻	≤5mΩ	
Insulation resistance/绝缘电阻	≥100MΩ	
Connector body/胶芯	TPU	
pins/端子	Brass with gold plated/黄铜镀金	
Screw/螺丝	Brass with nickel plated/黄铜镀镍	
Over-mold/成型	TPU	
Shielded sheath/屏蔽罩	Brass with nickel plated/黄铜镀镍	
Gasket/胶圈	Fluorine ring/氟胶圈	
Customs tariff number/海关编码	8518900001	
Environmental compliance/环境符合标准	RoHS, Reach	



## M5 male to male straight cable, shielded/M5公头直头对公直头连接线, 带屏蔽

### Scale drawing/尺寸图

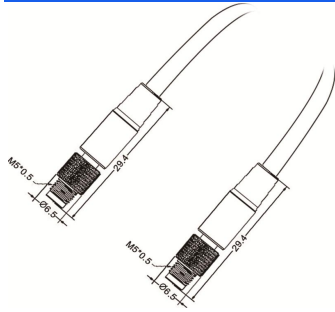

### Product photo/产品图



### Part number/产品料号

Pins/针数	Part number("X" is length millimetre mm)/产品料号("X"表示长度, 单位毫米mm)		
	PVC jacket/PVC外被	PUR jacket/PUR外被	
	-10°C~+80°C	-40°C~+105°C	-40°C~+105°C
3pins/3针	5L238-X	5L239-X	5L240-X
4pins/4针	5L218-X	5L250-X	5L251-X

### Pin assignment front view/针位分布前视图

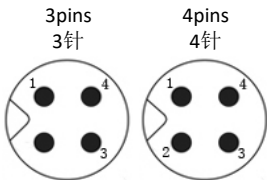

### General data/常规数据

Pin numbers/针数	3pins/3针	4pins/4针
Rated voltage/额定电压	60V	
Rated current(40°C)/额定电流	1A	
Standards/标准	IEC 61076-2-105	
Termination/焊接方式	Solder and over-mold/焊接和成型	
Connector locking system/锁紧方式	Screw/螺锁	
Degree of protection/防护等级	IP67, IP68, IP69K	
Wire gauge(mm²)/线规(平方数)	0.14mm²	
Wire gauge(AWG)/线号(平方数)	26AWG	
Mechanical operation/插拔次数	>100 mating cycles/大于100次	
Ambient temperature(operation)/操作温度	-25°C~+85°C	
Contact resistance/接触电阻	≤5mΩ	
Insulation resistance/绝缘电阻	≥100MΩ	
Connector body/胶芯	TPU	
pins/端子	Brass with gold plated/黄铜镀金	
Screw/螺丝	Brass with nickel plated/黄铜镀镍	
Over-mold/成型	TPU	
Shielded sheath/屏蔽罩	Brass with nickel plated/黄铜镀镍	
Gasket/胶圈	Fluorine ring/氟胶圈	
Customs tariff number/海关编码	8518900001	
Environmental compliance/环境符合标准	RoHS, Reach	



## M5 male straight to female right angle cable, shielded/M5公头直头对母头弯头连接线, 带屏蔽

Scale drawing/尺寸图

Product photo/产品图

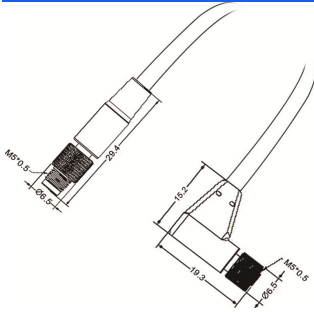

Part number/产品料号

Pins/针数	Part number("X" is length millimetre mm)/产品料号("X"表示长度, 单位毫米mm)		
	PVC jacket/PVC外被	PUR jacket/PUR外被	PUR jacket/PUR外被
3pins/3孔	-10°C~+80°C	-40°C~+105°C	-40°C~+105°C
4pins/4孔	5L229-X	5L230-X	5L231-X
	5L217-X	5L227-X	5L228-X

Pin assignment front view/针位分布前视图

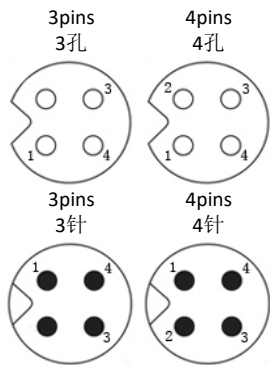

General data/常规数据

Pin numbers/孔数	3pins/3孔	4pins/4孔
Rated voltage/额定电压	60V	
Rated current(40°C)/额定电流	1A	
Standards/标准	IEC 61076-2-105	
Termination/焊接方式	Solder and over-mold/焊接和成型	
Connector locking system/锁紧方式	Screw/螺锁	
Degree of protection/防护等级	IP67, IP68, IP69K	
Wire gauge(mm²)/线规(平方数)	0.14mm²	
Wire gauge(AWG)/线号(平方数)	26AWG	
Mechanical operation/插拔次数	>100 mating cycles/大于100次	
Ambient temperature(operation)/操作温度	-25°C~+85°C	
Contact resistance/接触电阻	≤5mΩ	
Insulation resistance/绝缘电阻	≥100MΩ	
Connector body/胶芯	TPU	
Male pin/公端子	Brass with gold plated/黄铜镀金	
Female pin/母端子	Phosphorus copper with gold plated/磷铜镀金	
Screw/螺丝	Brass with nickel plated/黄铜镀镍	
Over-mold/成型	TPU	
Shielded sheath/屏蔽罩	Brass with nickel plated/黄铜镀镍	
Gasket/胶圈	Fluorine ring/氟胶圈	
Customs tariff number/海关编码	8518900001	
Environmental compliance/环境符合标准	RoHs, Reach	

## M5 male to female straight cable, shielded/M5公头直头对母头直头连接线, 带屏蔽

### Scale drawing/尺寸图

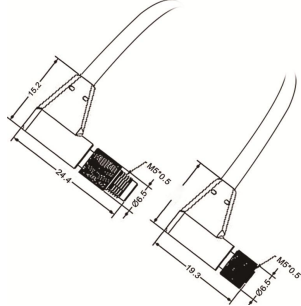

### Product photo/产品图



### Part number/产品料号

Pins/针数	Part number("X" is length millimetre mm)/产品料号("X"表示长度, 单位毫米mm)		
	PVC jacket/PVC外被	PUR jacket/PUR外被	
	-10°C~+80°C	-40°C~+105°C	-40°C~+105°C
3pins/3孔	5L219-X	5L220-X	5L221-X
4pins/4孔	5L201-X	5L216-X	5L117-X

### Pin assignment front view/针位分布前视图

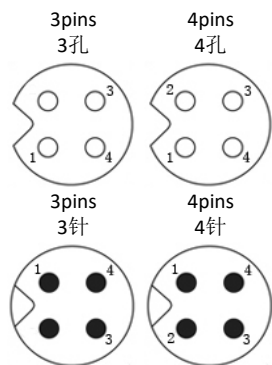

### General data/常规数据

Pin numbers/孔数	3pins/3孔	4pins/4孔
Rated voltage/额定电压	60V	
Rated current(40°C)/额定电流	1A	
Standards/标准	IEC 61076-2-105	
Termination/焊接方式	Solder and over-mold/焊接和成型	
Connector locking system/锁紧方式	Screw/螺锁	
Degree of protection/防护等级	IP67, IP68, IP69K	
Wire gauge(mm²)/线规(平方数)	0.14mm²	
Wire gauge(AWG)/线号(平方数)	26AWG	
Mechanical operation/插拔次数	>100 mating cycles/大于100次	
Ambient temperature(operation)/操作温度	-25°C~+85°C	
Contact resistance/接触电阻	≤5mΩ	
Insulation resistance/绝缘电阻	≥100MΩ	
Connector body/胶芯	TPU	
Male pin/公端子	Brass with gold plated/黄铜镀金	
Female pin/母端子	Phosphorus copper with gold plated/磷铜镀金	
Screw/螺丝	Brass with nickel plated/黄铜镀镍	
Over-mold/成型	TPU	
Shielded sheath/屏蔽罩	Brass with nickel plated/黄铜镀镍	
Gasket/胶圈	Fluorine ring/氟胶圈	
Customs tariff number/海关编码	8518900001	
Environmental compliance/环境符合标准	RoHs, Reach	

## M5 female to female right angle cable, shielded/M5母头弯头对母弯头连接线, 带屏蔽

### Scale drawing/尺寸图

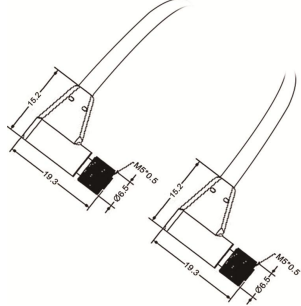

### Product photo/产品图



### Part number/产品料号

Pins/针数	Part number("X" is length millimetre mm)/产品料号("X"表示长度, 单位毫米mm)		
	PVC jacket/PVC外被	PUR jacket/PUR外被	
	-10°C~+80°C	-40°C~+105°C	-40°C~+105°C
3pins/3孔	5L247-X	5L248-X	5L249-X
4pins/4孔	5L258-X	5L259-X	5L260-X

### Pin assignment front view/针位分布前视图

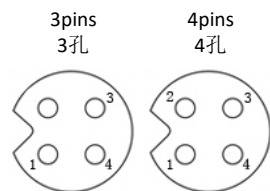

### General data/常规数据

Pin numbers/孔数	3pins/3孔	4pins/4孔
Rated voltage/额定电压	60V	
Rated current(40°C)/额定电流	1A	
Standards/标准	IEC 61076-2-105	
Termination/焊接方式	Solder and over-mold/焊接和成型	
Connector locking system/锁紧方式	Screw/螺锁	
Degree of protection/防护等级	IP67, IP68, IP69K	
Wire gauge(mm²)/线规(平方数)	0.14mm²	
Wire gauge(AWG)/线号(平方数)	26AWG	
Mechanical operation/插拔次数	>100 mating cycles/大于100次	
Ambient temperature(operation)/操作温度	-25°C~+85°C	
Contact resistance/接触电阻	≤5mΩ	
Insulation resistance/绝缘电阻	≥100MΩ	
Connector body/胶芯	TPU	
pins/端子	Brass with gold plated/磷铜镀金	
Screw/螺丝	Brass with nickel plated/黄铜镀镍	
Over-mold/成型	TPU	
Shielded sheath/屏蔽罩	Brass with nickel plated/黄铜镀镍	
Gasket/胶圈	Fluorine ring/氟胶圈	
Customs tariff number/海关编码	8518900001	
Environmental compliance/环境符合标准	RoHS, Reach	

## M5 code female straight to female right angle molded cable, shielded/M5, 母头直头对母头弯头连接线, 带屏蔽

### Scale drawing/尺寸图

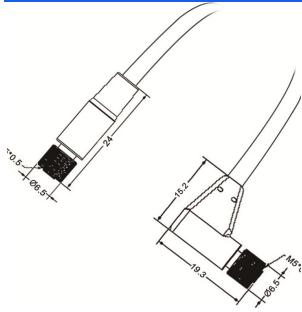

### Product photo/产品图



### Part number/产品料号

Pins/针数	Part number("X" is length millimetre mm)/产品料号("X"表示长度, 单位毫米mm)		
	PVC jacket/PVC外被	PUR jacket/PUR外被	
	-10°C~+80°C	-40°C~+105°C	-40°C~+105°C
3pins/3孔	5L267-X	5L268-X	5L269-X
4pins/4孔	5L270-X	5L271-X	5L272-X

### Pin assignment front view/针位分布前视图

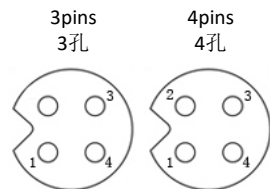

### General data/常规数据

Pin numbers/孔数	3pins/3孔	4pins/4孔
Rated voltage/额定电压	60V	
Rated current(40°C)/额定电流	1A	
Standards/标准	IEC 61076-2-105	
Termination/焊接方式	Solder and over-mold/焊接和成型	
Connector locking system/锁紧方式	Screw/螺锁	
Degree of protection/防护等级	IP67, IP68, IP69K	
Wire gauge(mm²)/线规(平方数)	0.14mm²	
Wire gauge(AWG)/线号(平方数)	26AWG	
Mechanical operation/插拔次数	>100 mating cycles/大于100次	
Ambient temperature(operation)/操作温度	-25°C~+85°C	
Contact resistance/接触电阻	≤5mΩ	
Insulation resistance/绝缘电阻	≥100MΩ	
Connector body/胶芯	TPU	
pins/端子	Brass with gold plated/磷铜镀金	
Screw/螺丝	Brass with nickel plated/黄铜镀镍	
Over-mold/成型	TPU	
Shielded sheath/屏蔽罩	Brass with nickel plated/黄铜镀镍	
Gasket/胶圈	Fluorine ring/氟胶圈	
Customs tariff number/海关编码	8518900001	
Environmental compliance/环境符合标准	RoHS, Reach	



## M5 one female to two male Y splitter connector/M5,1母对2公Y型连接器

### Scale drawing/尺寸图

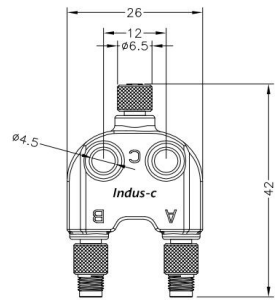

### Product photo/产品图



### Part number/产品料号

Pins/针数	Part number/产品料号
4pins/4针	5Y00002

### Pin assignment front view/针位分布前视图

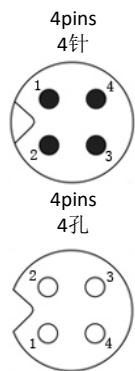

### General data/常规数据

Pin numbers/针数	4pins/4针
Rated voltage/额定电压	60V
Rated current(40°C)/额定电流	1A
Standards/标准	IEC 61076-2-105
Termination/焊接方式	Solder/焊接
Connector locking system/锁紧方式	Screw/螺锁
Degree of protection/防护等级	IP67, IP68, IP69K
Wire gauge(mm²)/线规(平方数)	0.14mm²
Wire gauge(AWG)/线号(平方数)	26AWG
Mechanical operation/插拔次数	>100 mating cycles/大于100次
Ambient temperature(operation)/操作温度	-25°C~+85°C
Contact resistance/接触电阻	≤5mΩ
Insulation resistance/绝缘电阻	≥100MΩ
Connector body/胶芯	TPU
Pin/端子	Brass with gold plated/黄铜镀金
Nut and shell/螺母和铜壳	Brass with nickel plated/黄铜镀镍
Customs tariff number/海关编码	8538900000
Environmental compliance/环境符合标准	RoHs, Reach